

Register your product and get support at
www.philips.com/welcome

SDV8622/12



User manual

PHILIPS

Contents

1	Important	4
	Safety	4
	For indoor use	4
	For outdoor use	4
	Recycling	4

2	Your SDV8622/12	5
	What's in your box	6

3	Get started	7
	Installation	7
	Connect to the TV	10
	Set up a digital tuner with this antenna	10

4	Frequently asked questions	11
----------	-----------------------------------	----

5	Warranty and service	11
----------	-----------------------------	----

6	Glossary	12
----------	-----------------	----

1 Important

Safety

This manual contains important information about the Philips indoor/outdoor television antenna. Read it carefully before you start the installation and setup.

For indoor use

- The product shall not be exposed to dripping or splashing and no objects filled with liquid, such as vases, shall be placed on the product.
 - To completely disconnect the power input, the main plug of the product shall be disconnected from the main AC outlet.
 - Where the main plug is used as the disconnect device, the disconnect device shall remain readily operable.
 - No naked flame sources, such as lighted candles, should be placed on the product.
-

For outdoor use

- If this is the first time you install an antenna, for your own safety as well as others, seek professional assistance.
- Perform as many functions as possible on the ground.
- Select your installation site carefully. Remember: electric power lines and phone lines look alike. For your safety, assume that all overhead lines may cause fatal injury.
- Ensure that the installation site is structurally capable to support all loads (weight of the antenna, weight of ice, weight of snow and wind force).

- Properly sealed against leaks at the installation site.
 - Do not install your antenna on a wet or windy day.
 - If the assembly starts to drop, get away from it immediately. Remember: the antenna, mast, cable, and metal guy wires are all excellent conductors of electrical current. Even the slightest touch of any of these parts to a power line can cause electrocution and death.
 - If any part of the antenna system should come in contact with a power line, don't touch it or try to remove it yourself. Call your local power company. They will remove it safely.
 - If an accident occurs with the power lines, call for qualified emergency help immediately.
-

Recycling



Your product is designed and manufactured with high quality materials and components, which can be recycled and reused.

When you see the crossed-out wheel bin symbol attached to a product, it means the product is covered by the European Directive 2002/96/EC:



Never dispose of your product with other household waste. Please inform yourself about the local rules on the separate collection of electrical and electronic products. The correct disposal of your old product helps prevent potentially negative consequences on the environment and human health.



When this logo is attached to a product, it means a financial contribution has been paid to the associated national recovery and recycling system.

© 2012 Koninklijke Philips Electronics N.V. All rights reserved. Reproduction in whole or in part is prohibited without the written consent of the copyright owner. Trademarks are the property of Koninklijke Philips Electronics N.V. or their respective owners.



2 Your SDV8622/12

Congratulations on your purchase and welcome to Philips!

To fully benefit from the support that Philips offers, register your product at www.philips.com/welcome.

What's in your box

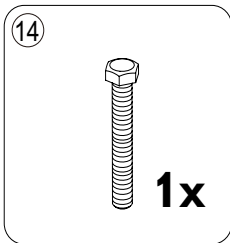
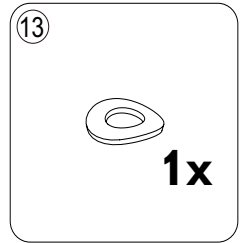
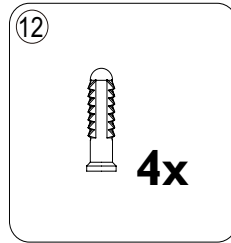
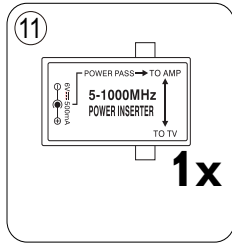
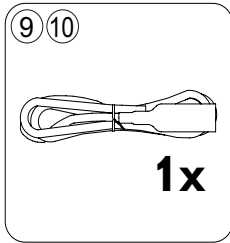
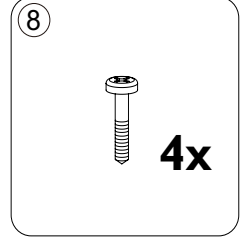
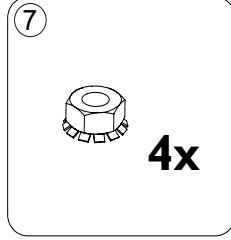
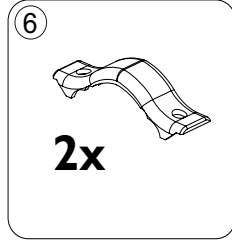
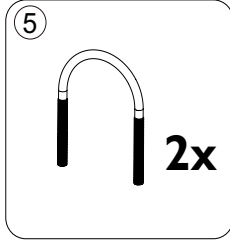
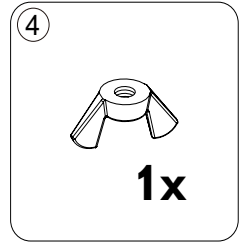
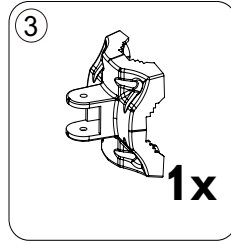
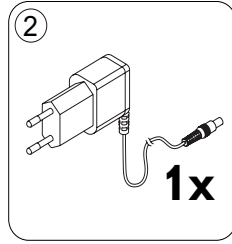
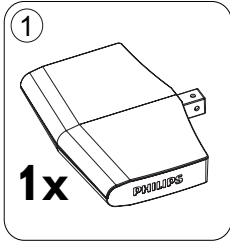

① SDV8622/12 antenna

② Power supply 100-240V AC / 6V DC 500mA

③ Wall/Mast bracket

④ Nut

⑤ U-Bolts

⑥ Mast clamps

⑦ Nuts with lock washers

⑧ 25mm wood screws

⑨ 6m coax cable with connectors

⑩ Weather boot

⑪ Power inserter

⑫ Plastic anchors

⑬ Washer

⑭ 40mm Hexagon screw

3 Get started

Installation

Installation information

This antenna uses a power inserter module to power the antenna amplifier.

It is essential for proper operation of this antenna system that the power inserter be connected between the antenna and any devices such as splitters, matching transformers, networks, etc.

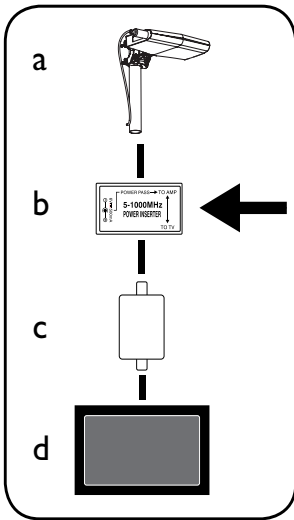

a	Antenna with built-in amplifier
b	Power inserter module
c	Splitters or matching transformers (not included)
d	TV or video device

Determine the signal strength

Before Installation, determine the best location for optimum reception. It is important for the antenna to have an unobstructed path to the transmitter. For best results, ensure the antenna faces the location of the transmitter.

Note

- Indoor, choose a location near a window which gives the antenna a clear view of the transmitter.

Note

- Place the antenna away from metal surface to avoid interference.

For indoor wall mount installation

Note

- Complete all assembly work on the ground before installing on a wall or an antenna mast.

- Use the nut ④, washer ⑤, and hexagon screw ⑥ to attach the antenna to the wall/mast bracket.

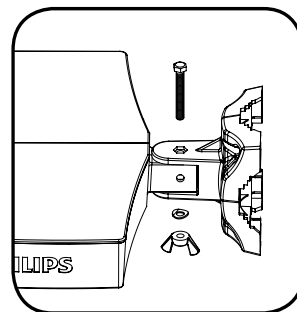

- 2 Use the screw holes of the wall/mast bracket ③ as a guide to mark position for the wood screws.

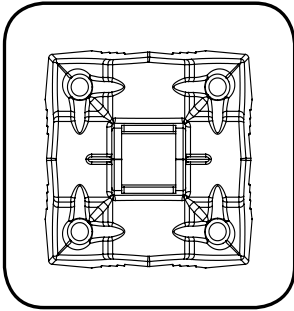

- 3 Use the wood screws ⑧ to fix the antenna to the wood wall firmly.

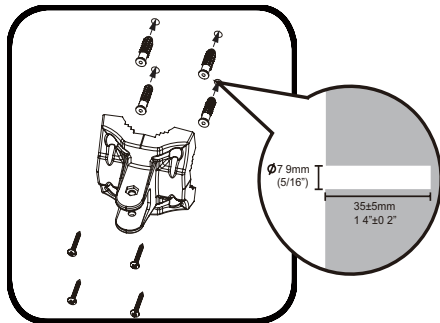
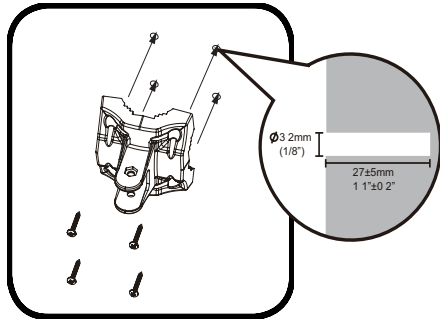

For outdoor mast mount installation

Note

- Complete all assembly work on the ground. Raise the completed antenna after assembly.

- 1 Use the nut ④, washer ⑨, and hexagon screw ⑩ to attach the antenna to the wall/mast bracket.

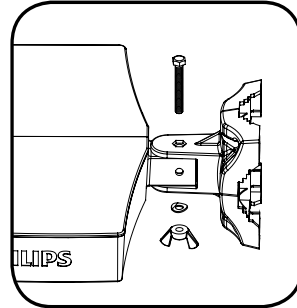

- 2 Insert U-bolts ⑤ into the holes of the wall/mast bracket ③. Slide the mast clamps ⑥ onto the U-bolts ⑤. Attach the four nuts with lock washers ⑦ to the U-bolts ⑤.

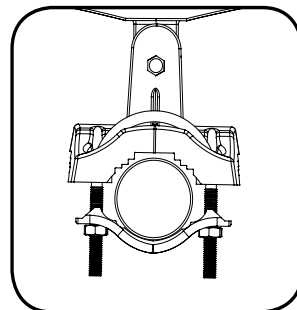

- 3 Attach the assembly to the mast firmly.

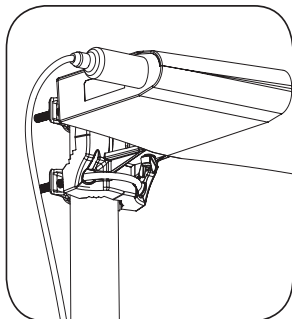

- 4 Rotate the mast in its mount to adjust the direction.

- 5 Attach the coaxial cable ③ to the F connector on the underside of the unit. Position the weather boot ④ over the connection.

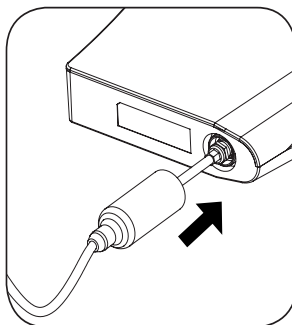

Rotate

You can make a 90 degree rotation to the antenna or the mounting post.

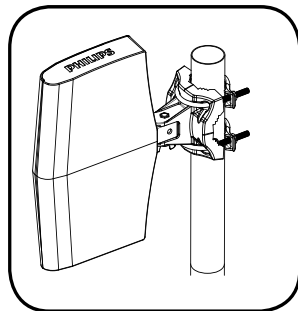
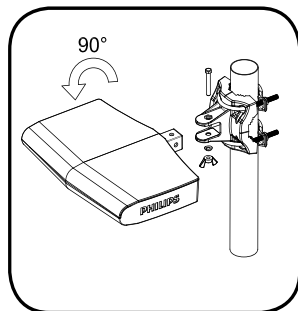

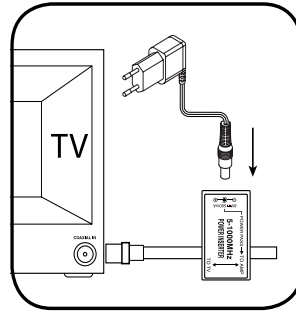
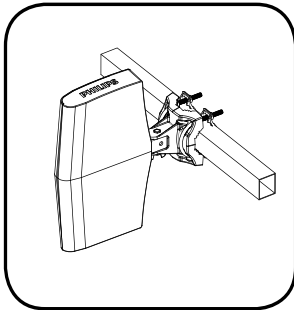
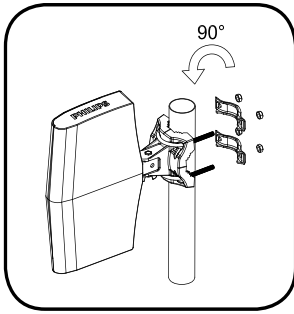

Warning

- The power inserter and power supply are for indoor use only.

Tip

- This antenna includes a 6m roll of 3C-2V coaxial cable. If this is not adequate for your needs, replace the cable with a RG-6 coaxial cable instead of adding an extension.

Connect to the TV

Note

- As previously noted, the amplifier (Power inserter + Power supply) must be placed in-line between the antenna and any splitter or additional devices.

- 1 Connect the coaxial cable ① from the antenna to the connector labeled AMP on the power inserter ④.
- 2 Connect the power inserter ④ to the antenna input on the TV, digital set-top box, splitter or other devices.
- 3 Connect the power supply plug ② to the power inserter ④, and then plug the power supply adaptor ② into a 100-240V AC receptacle.

Set up a digital tuner with this antenna

You can install available channels with the digital TV tuner. This automatic process is part of the setup of the tuner. Ensure the antenna has set up properly before the tuner can receive viewable channels.

There are two ways to connect the antenna to the TV:

- Connect the antenna to a digital tuner. If the signal strength is good enough, the channels can be memorized in the tuner automatically.
- Connect the antenna directly to the TV. Tune to the analogue channels and find the best antenna location. Then re-connect the antenna to the digital tuner. Ensure the signal strength is good enough before you install the channels with the tuner.

4 Frequently asked questions

Can this antenna work with Analogue transmissions?

Yes, this antenna can receive analogue television broadcasts in the UHF and VHF bandwidths.

Can this antenna receive digital or work with HD-DVB broadcasts?

Yes, this antenna is designed to receive digital DVB and HDTV broadcasts in the UHF & VHF bandwidths.

Can the antenna be powered by a DC power supply in a boat, RV or camper?

Yes, there is a DC power socket located at the "power inserter". Plug your cable/adaptor into the antenna and then into your power source with correct rating (6V DC, 500mA), polarity and plug type.

Where should I place the antenna in order to get the best reception possible?

Choose a location near a window which gives the antenna a clear view of the transmitter.



Tip

- For best reception, place the antenna away from metal surface to avoid interference.

Can I set up this antenna with a digital tuner?

Yes, this antenna can be set up with a digital tuner (see the section on "Set up a digital tuner with this antenna").

5 Warranty and service

Warranty information can be found at: www.philips.com/welcome

For technical support, send us an email with the model number of the product and a detailed description of your problem to accessorysupport@philips.com

6 Glossary

A

Amplifier

A device, either a single stage or a large scale circuit with multiple stages for creating gain, i.e. it makes small signals larger.

Antenna

A device, such as a rod or wire, which picks up a received radio frequency signal or radiates a transmitted RF signal.

C

Coaxial

A single copper conductor, surrounded with a layer of insulation, covered by a surrounding copper shield and finally, an insulating jacket. An unbalanced transmission line with constant impedance. In audio, this type is commonly used for low level, line signals terminated in RCA connectors.

D

DVB (Digital Video Broadcasting)

DVB is a suite of internationally accepted open standards for digital television.

F

FM (Frequency Modulation)

In radio broadcasting: a method of modulation in which the frequency of the carrier voltage is varied with the frequency of the modulation voltage.

H

HDTV (High-Definition Television)

It is a digital television broadcasting system with higher resolution than traditional

television systems (standard-definition TV, or SDTV). HDTV is digitally broadcast; the earliest implementations used analog broadcasting, but today digital television (DTV) signals are used, requiring less bandwidth due to digital video compression.

U

UHF (Ultra high frequency)

In radio or TV broadcasting: it is the frequency range of electromagnetic waves which lies between 300 MHz and 3 GHz (3000 MHz).

V

VHF (Very high frequency)

In radio or TV broadcasting: it is the frequency range of electromagnetic waves which lies between 30 MHz and 300 MHz.

